

Feeding Mechanism in the Rattlesnake *Crotalus durissus*

K.V. Kardong¹), P. Dullemeijer²), J.A.M. Fransen²)

Abstract. Cineradiography and electromyography were used to study the strike and swallowing behaviour of the rattlesnake, *Crotalus durissus*. From the data gathered, we describe the kinetic events of the cranial bones correlated with both the activity of individual jaw muscles (electromyograms) and with the calculated relative forces produced by these same muscles. During the strike, the independently suspended jaws of left and right sides simultaneously protract to erect the folded fangs. This is accompanied by opening of the lower jaws. Some low level activity first appears in the depressor muscles, but immediately thereafter they and all other jaw muscles suddenly and nearly simultaneously reach peak output. From the calculated relative muscle forces, vector models of the jaws were determined for early and peak points in the strike. Swallowing is accomplished by reciprocating alternate motions of bones on the left and right sides of the skull. This produces a swallowing cycle of two phases, moving and fixing. In turn, each phase divides into three parts—opening, advance, close. On the ipsilateral side, opening is characterized by a relaxation of contact of bones and teeth they bear with the prey and the braincase begins rotation about three axes simultaneously. Motions begun in opening, continue into advance, but now the ipsilateral jaw elements are protracted to progress them along the prey. As protraction ends, the jaws again come into contact with the prey to establish the close part of the moving phase of swallowing. After a pause, the fixing phase begins while opposite jaw elements now take their turn to progress through similar displacements. During this fixing phase ipsilateral elements are often further retracted. Emphasis is given to the complicated rotations of the braincase which contribute first to disengagement of teeth and second to advancement of suspended jaw elements around and along the prey. Most muscles reached peak output during one of the two swallowing phases, although the timing and intensity of these peaks varied between muscles. The relative muscle forces were used to construct vector models of the jaws during stages of swallowing. Upon these vector models and from the overall patterns of activity, determination was made of the likely roles played by individual muscles in abduction, protraction, and adduction of jaw elements. Muscles, besides being basic movers of the jaw elements, apparently also play critical parts in stabilizing and regulating the controlled positioning of bones.

1. Introduction

The feeding mechanism and jaw apparatus in rattlesnakes exhibits a high degree of kinematic movement due to the presence of many loosely articulating parts (Klauber, 1956; Dullemeijer, 1959). The jaw apparatus participates in striking, swallowing of

¹) Washington State University, Pullman, Washington, U.S.A.

²) Department of Zoology, University of Leiden, NL-2300 RA Leiden, The Netherlands

prey, and in the drinking of water. Although there is potentially great freedom of movement of cranial elements in such a multilinkage system (Frazzetta, 1966), actual kinematic displacements are controlled by ligaments, articular surfaces, and muscular activity (e.g. Kardong, 1974). Due to the loose connections in the jaw apparatus, the bony elements can be considered statically determinate constructions. Consequently, the set of mechanical demands placed upon the jaw apparatus can be calculated and then used to explain the actual shapes of particular bones that experience these demands (Dullemeijer, 1956, 1958, 1959, 1970). However, the calculated mechanical demands can only be derived from accurate observations of cranial movements and measurement of muscle activity in living animals. Although high speed cinematography and cineradiography have been used to inspect directly the activity of the cranial elements (Dullemeijer & Povel, 1972; Kardong, 1974, 1977), most previous analyses of cranial activity have relied upon indirect inferences from the study of mechanical linkages in anatomical dissection (Kathariner, 1900; Haas, 1931; Klauber, 1956; Dullemeijer, 1956, 1959). In this study, direct observations of movements of bony elements by means of cinefluorography and of muscle activity by electromyography were used. First, these observations are made to check the suggested activity underlying the calculations of the mechanical demands. Second, this analysis has led to some new interpretations of the jaw apparatus of the rattlesnake, *Crotalus durissus*.

2. Materials and Methods

Two *Crotalus durissus ruruima* Hoge, approximately 1 meter in overall length, were used in the experiments. They were fed with mice 25-30 grams. For the radiography experiments, the snakes were kept in a cage of 50 x 50 x 50 cm, to which a narrow observation tube of 90 x 10 x 50 cm was attached. The sides and the bottom of the observation tube were made of X-ray transparent material. By presentation of a freshly killed rat at the far end of the tube, the snake could be coaxed to enter, and feeding proceeded in a specific space necessary for cinefluorography and myography. Strike and swallowing took place conveniently within this tube and did not differ from those observed for a living rat. A previous study of feeding behaviour (Dullemeijer, 1961) gave us confidence that the experimental apparatus did not significantly disrupt normal behaviour.

2.1 Dissection

Several heads, of the same species of snakes and of about the same size as the live specimens, preserved in formaldehyde and kept in 70% alcohol were used for dissection.

From these dissected heads we determined muscle attachment, fiber orientation, and cross-sectional area of the muscles. The attachments and the structure of the muscles were not significantly different from those described in earlier publications (Dulle-

meijer, 1959; Haas, 1931; Kardong, 1974, 1977). Each muscle was transected across its belly at its widest part. The cut end was dipped in ink, blotted to remove excess ink, and then pressed onto graph paper. A Numonics digitizer was used to calculate the cross sectional area of the ink impression for each muscle. This procedure is appropriate since the muscles are fixed in a relaxed state and are parallel-fibred with the exception of the adductor pterygoideus, which is so close to parallel-fibred that we felt justified in treating it as such.

Another head was used to study in microscopic section the ectopterygoid-ptyergoid joint to check the former observations by Dullemeijer & Povel (1972). After decalcification and embedding in epon, the joint was cut longitudinally in 10 μ sections, of which one out of five were stained according to the method of Mallory-Cason. Anatomical nomenclature follows Dullemeijer (1956, 1959) and Haas (1973).

2.2 Kinematics

Cinematography (75 fps) of swallowing was taken simultaneously with electromyography. A camera shutter pulse was recorded next to the electromyographic traces on chart paper so that the jaw movement could be directly matched with the recorded muscle activity.

Separately from the electromyography, both cineradiography and single radiographs of swallowing were taken. The snake was guided by a scent track of prey into the narrow observation tube described above. Tube and cage could be moved and gently positioned in front of the X-ray source. Osray-M3 X-ray plates, in a holder, were placed on the outside backwall of the tube. This procedure facilitates easy, quick change of plates, without much disturbance of the snake and results in little image distortion because of the very short distance of the snake head to the plate. The Siemens-Gigantos X-ray apparatus was placed at 80 cm from the plate, exposures 85 kV, 180 mA and 0.01 sec. For dorso-ventral exposures the plates were shifted into a glider on the bottom of the observation tube. Here 85 kV was used and the distance between X-ray tube and plate was 60 cm. Cineradiography was performed basically in the same way. The cineradiographic unit used an image intensifier, Sirecca, and a 35 mm camera, with a Copex-pan film, run at 48 fps. Exposure 105 kV, 75 mA, 2 msec. Contrast position 1 sec and number 3.

Cineradiography was used to determine qualitative aspects of jaw mechanics (e.g., sequences of jaw displacements). The single radiographs yielded a quantitative measure of bone displacement ordered in proper sequence according to the cineradiographs. Appropriate single radiographs were obtained by selecting from many radiographs only those with right angle alignment to the X-ray tube and film (i.e., the shadows of both postorbital bones must exactly overlap). The other radiographs were used as additional qualitative information.

The radiographs were printed on photographic paper that increased contrast (Fig. 1). From these printed pictures, selected reference points (Fig. 2) were read into a computer which calculated changes in position and angles between movable bones.



Fig. 1. Rontgenogram of a stage in the swallowing of a dummy mouse (meatball covered with mouse skin). Easily recognizable are the various bars in the jaw apparatus: lower jaws, quadrates, supratemporals, entopterygoids, ectopterygoids, maxillae, with poison fangs, prefrontals and the bones and processus which served for reference points: orbits with postorbitals and skull basis.

2.3 *Electromyography*

One snake at a time was used several times for electromyography. The basic procedure for transforming electromyograms into graded block diagrams follows Osse (1969), and Zweers (1974). Anaesthetization with halothane (Flurothane) was a two-step procedure: first, the snake was placed in a plastic box with cotton soaked in halothane. When no righting reflex was detected, the snake was moved to the operating table. Second, a catheter was now inserted down the trachea about 15 cm beyond the head (total length of the snake was 120 cm). The catheter was connected to a tube that supplied various mixtures of O_2 , N_2O and 1 vol. % halothane. Through the catheter, this stream of gasses was directed into the lungs. Finally, a syringe needle was inserted posteriorly between the ribs but close to the vertebrae into the air sac of the lung. Thus, the gas mixture introduced anteriorly via the catheter passed over the respiratory faveoli of the lung and escaped posteriorly via the syringe needle. A one-way of anaesthetizing gasses could thus be established that did not depend upon respiratory movements of the snake. Further, O_2 or air could be flushed through the lungs at the end of the operation to speed recovery. Recovery was quick, usually less than one hour. Three hours post-surgery the snake swallowed dead mice, and 18 hours later it struck and swallowed on its own.

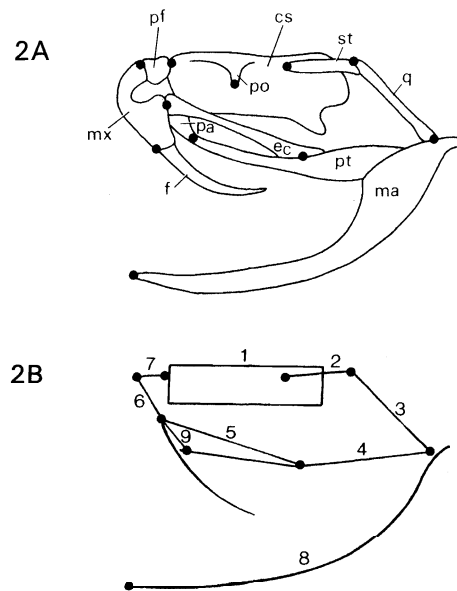

Fig. 2. Cranial elements of *Crotalus* skull.

- A. Lateral view of cranial elements. The dark circles are joints or reference points used to follow kinematic displacements of the bones.
- B. Seven-bar linkage chain representing the movable elements of the snake skull. Bar 1 is the cerebral skull, the reference frame. Bar 8 is the mandible, bar 9 is the palatine.

cs: cerebral skull	pf: prefrontal
ec: ectopterygoid	po: postorbital process
f: fang	pt: pterygoid
ma: mandible	q: quadrate
mx: maxilla	st: supratemporal
pa: palatine.	

Small incisions in the skin were made to expose preselected muscles. A unipolar silver electrode (0.05 mm diameter, enamel coated) with a hooked end was pushed with a forked needle (Osse et al., 1972) into restricted parts of each exposed and visible muscle. A single reference electrode, 0.1 mm enamel coated silver, was slipped between the skin and the skull dorsally between the orbits. The electrodes were gently bundled together, glued with cyanolit, run along and sutured to the back of the snake for about a quarter of its length, and the free leads connected to a balancing weight.

We are aware of the risk in using unipolar electrodes; in view of the size of many muscles there was no other choice. However, volume conduction could be easily detected. Comparing the various activities, volume conduction could be ruled out with probably only one exception. Moreover, the conclusions have been restricted, to general phenomena. We refrained from details and interpretations of small outputs. Radiographs in two directions were taken just after surgery and later after the experiments to check electrode placement.

The snake was placed in a grounded terrarium within a Faraday cage.

Muscle output was amplified by a Tektronix FM 122 preamplifier and recorded on a SE 7000 14 channel band recorder. Display occurred on a Siemens oscillomink chart recorder. Simultaneously, films were made with a Bolex 16 mm camera with shutter synchronisations recorded with electromyograms.

Two sets of eight muscles were recorded simultaneously several hundred times on various days. Each set included at least one in common with previously run sets of eight muscles as a further method of comparing and aligning muscle activity.

2.4 Muscle Forces

The calculations of the relative muscle forces during swallowing were based upon the following central assumptions: (cf. Weijs & Dantuma, 1975)

- 1) the magnitude of the force is directly proportional to the cross sectional area of the muscle.
- 2) the magnitude of the force of a muscle is directly proportional to its registered electrical output (electromyogram).
- 3) the peak force of a muscle for its cross sectional area is shown by the highest peak in the electromyogram. This will generally be during the strike.

Thus, the relative force generated by a muscle during swallowing was determined by:

$$F_r = ab(E_s/E_m)$$

where the relative force (F_r) is equal to the product of the muscle's cross sectional area (a) times its force per cm² (b) times the proportion of EMG activity during swallowing (E_s) to maximal EMG activity (E_m) recorded during the experiment.

Two approaches were now used to represent the myographic results. First, qualitative block diagrams of myograms were constructed. During a strike or single swallowing cycle, each active muscle produced a myogram. This spike train was inspected for its point of greatest peak. This maximum peak was then divided into three equal stepped levels (maximum, intermediate, baseline). Each part of the myograms for that muscle were then visually assigned to one of the three levels that best seemed to fit. The results are represented accordingly. Second, relative muscle forces were calculated. Recorded EMG signals were rectified then integrated over each 0.01 second interval of muscle activity. The single highest such integrated value obtained for each muscle was used as its E_m . In each muscle, E_m occurred during the strike. All rectified and integrated values obtained for that same muscle during swallowing at 0.01 second intervals were now taken as E_s . The ratio of E_s to E_m times "a" and "b" gave the relative muscle force at each interval. For present purposes, 'b' can be taken as unit force, thus 1 kg/cm². For our comparisons, this relative force determination is adequate, although it would be interesting to know in the future the absolute force output. Values of E_m and E_s were, of course, always taken from the same muscle during the same feeding trial with electrodes in the same position. These relative force values were plotted.

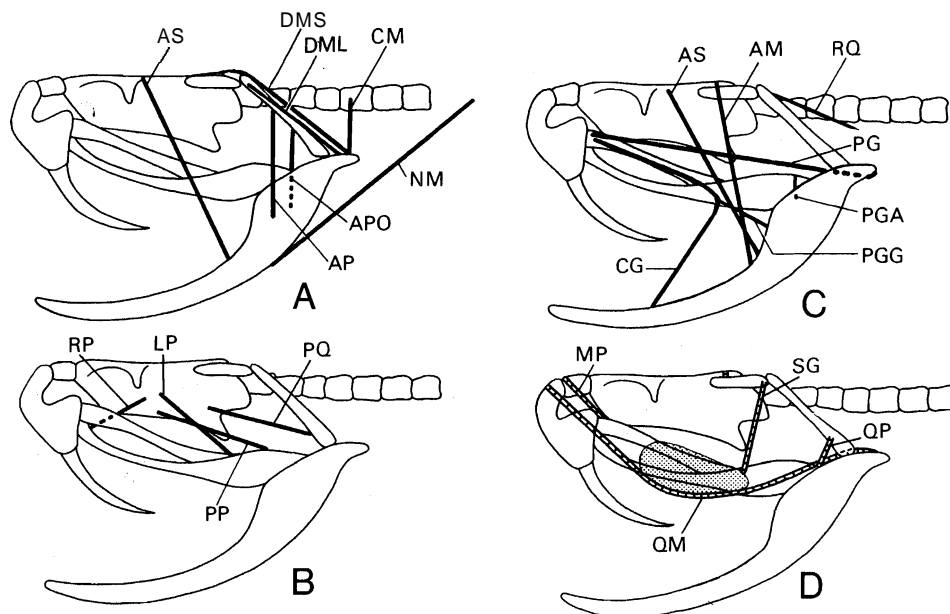

Fig. 3. The course of lateral jaw muscles is shown in A-C. Attachment sites lie in the centers of respective areas of origin or insertion. In D, the main ligaments that support the venom gland (shaded) or restrict motion are shown.

- AM: musculus adductor mandibulae externus medialis;
 AP: musculus adductor mandibulae externus profundus;
 APO: musculus adductor mandibulae posterior;
 AS: musculus adductor mandibulae externus superficialis;
 CG: musculus compressor glandulae;
 CM: musculus cervicomandibularis;
 DML: musculus depressor mandibulae (lateral division);
 DMS: musculus depressor mandibulae (cranial division);
 LP: musculus levator pterygoidei;
 NM: musculus neuromandiularis;
 PG: musculus pterygoideus;
 PGA: musculus pterygoideus accessorius;
 PGG: musculus pterygoideus pars glandulae;
 PP: musculus protractor pterygoidei;
 PQ: musculus protractor quadrati;
 RP: musculus retractor palatini;
 RQ: musculus retractor quadrati;
 MP: ligamentum maxillo-prefontale;
 QM: ligamentum quadrato-maxillare;
 QP: ligamentum quadrato-ptyergoidale;
 SG: ligamentum supratemporale-glandulare.

The muscle forces plotted are taken from many recordings made on two separate days with electrodes in different muscles, although two of the same muscles (pterygoideus and profundus) were recorded on each occasion to match the observations. Electrodes were placed in eight muscles on the right side or in eight muscles on the left side.

3. Results

3.1. Morphology

In general, the structures of the skeletal elements, the ligaments, and the muscles are the same as in the *Crotalus* species described earlier (Dullemeijer, 1959; Dullemeijer & Povel, 1972; Haas, 1973). The attachment sites and general courses of the muscles are shown in Fig. 3.

The muscles examined are simple parallel-fibred type (Dullemeijer, 1959) except for the pterygoideus muscle which is pinnate. The muscles are therefore schematically considered to be tension bands (Fig. 3) represented by vectors drawn parallel with the axis of each muscle. Ligaments are numerous. They can be considered simple tension-resistant bands.

3.2. Kinematics

The entire skull rotates about an axis in the anterior part of the vertebral column carrying with it suspended cranial elements movable relative to the cerebral skull. These movable elements form a seven-bar linkage chain with two freely extending bars (Fig. 2B). Bar 1 is the reference frame, the cerebral skull including the orbital and ethmoidal regions. Bars 2 and 7 suspend the jaws, namely, bars 3, 4, 5, and 6. The mandible is bar 8 suspended from the quadrate (bar 3). The palatine (bar 9) rides on the front of the pterygoid (bar 4), but seems to play only a minor part in controlling bone displacement, so is not included in the motion figures. Since bones on both sides are only loosely cross-connected by the intermandibular ligament and integument, independent movement of the seven-bar linkage chains on both sides is possible (cf. Gans, 1961).

The movement of the various bars of linked cranial bones has been described before by various authors (Haas, 1929; Haas, 1931; Klauber, 1956; Dullemeijer, 1956, 1959; Dullemeijer & Povel, 1972; Kardong, 1974, 1977). Our findings with *Crotalus* are in general agreement. However, the involvement of the neck and anterior vertebra column in movements of the head should be stressed more than has been done previously. The entire head moves with respect to the body in an up-and-down as well as lateral direction by flexions in the cervical region. The head is lifted considerably during the strike, somewhat more than 60° , while the mouth simultaneously opens, so that the lower jaw becomes almost perpendicular to the body axis. Moreover, it should be stressed that during swallowing the cerebral skull can be pushed forward between the jaws by straightening of curves in the cervical region (Dullemeijer, 1956).

3.2.1 Strike and Yawn

The strike and yawn have been equated (Dullemeijer & Povel, 1972), the yawn being considered a "slow" strike as far as movements of the bony elements are concerned.

We were not able to check this by fluorography. However, from what can be seen and inferred from high speed cinematography of the bone and fang movement, the yawn seems to be a reasonable model for what happens during the strike (Fig. 4).

Yawns occurred in various intensities for different jaws. Generally the head lifted to about a 50° angle with the vertebral column. The lower jaw was depressed. The proximal end of the quadrate moved upward and medially as its distal end swung forward accompanied by the posterior end of the pterygoid which moved upward and forward.

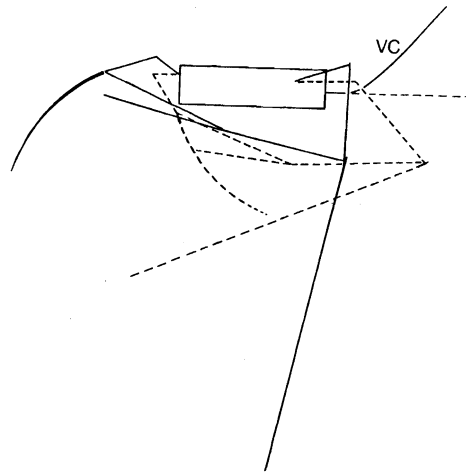

Fig. 4. The seven-bar linkage chain during the yawn. Dashed lines, rest position. Solid lines, full yawn. Comparison of two bone positions relative to cerebral skull (rectangle). Similar bone displacements are assumed to occur during the strike. vc, vertebral column position relative to cerebral skull; actually the vertebral column is kept almost horizontal.

The ectopterygoid, riding forward on the pterygoid, in turn pushed the maxilla into an erect position. The most notable features were the straightening in the joint between the pterygoid and ectopterygoid, the dorso-medial movement of the supratemporal, and the upward rotation of the prefrontal. These findings conform to earlier descriptions (Dullemeijer & Povel, 1972).

3.2.2 Swallowing (Fig. 5)

Swallowing in rattlesnakes, as in other snakes, was accomplished by alternate left and right movements of the jaws over the prey. Thus, each side passed through two basic phases during a single swallowing cycle—a moving and a fixing (= ipsilateral and contralateral) phase. During a feeding sequence made up of many cycles, each cycle included two phases separated by a rest interval. Finally, each phase was divided into three parts—opening, advance, and close.

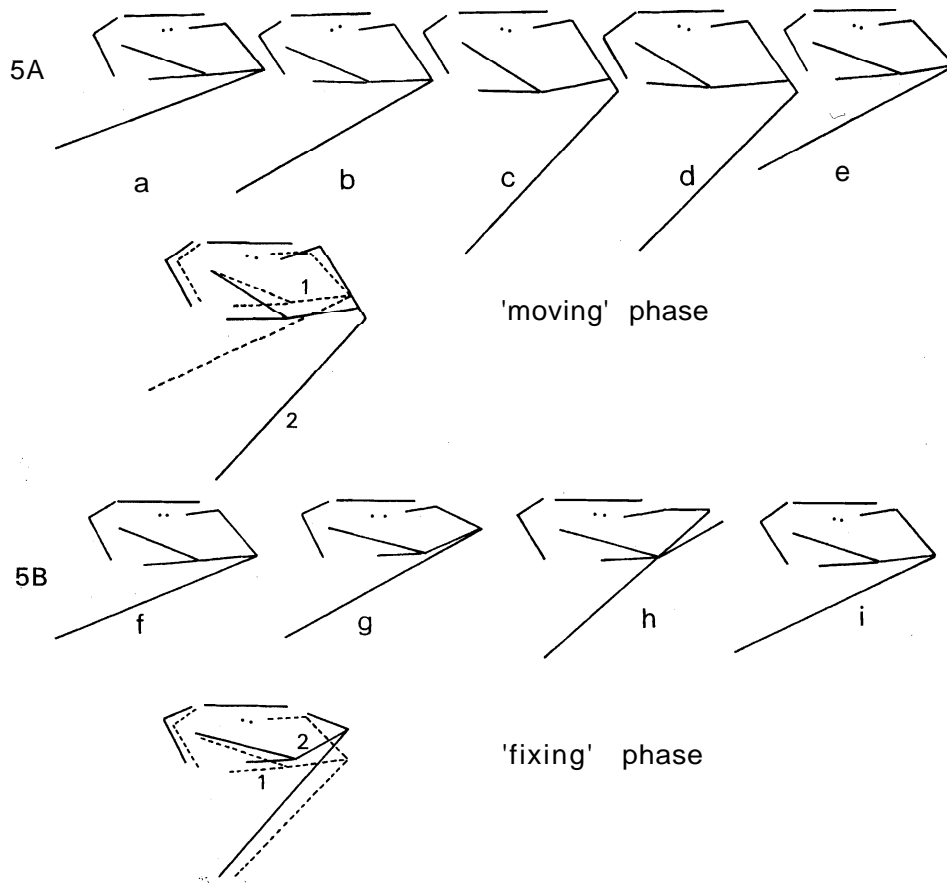

Fig. 5. Displacements of cranial linkages during swallowing as traced from serially arranged radiographs. A, 'moving phase'; B, 'fixing phase'; extreme position (2, straight lines) is overlapped with the rest position (1, broken lines).

3.2.2.1 *Moving Phase* (Fig. 5A)

Opening

Opening began when the jaws first relaxed their grip on the prey, and the mandible rotated with its upper side slightly outwards about its long axis to relax its pressure against the prey. The quadrato-mandibular joint, distal end of the quadrate, and proximal end of the mandible began forward and lateral motion relative to the braincase.

The braincase began rotation about three axes simultaneously—about its longitudinal axis, about a vertical axis passing through the middle of the braincase, and upward rotation about a transverse axis passing approximately through the neck but changing in position. Rotation about the horizontal axis caused the moving or the

lift of the ipsilateral side away from the prey and the fixing (= contralateral) side to press down more firmly on it; rotation about the vertical axis through the middle of the braincase swung the rostral ipsilateral elements outward from and along the prey; rotation about the transverse axis through the neck tended to lift the snout from the prey. The palatamaxillary arch also began protrusion during opening. Due to the rotations of the braincase to which it was coupled, the ipsilateral palatamaxillary arch lifted away from and over the prey.

Advance

During advance, depression of the mandible, protraction of the quadratomandibular joint, and elevation of the ipsilateral palatamaxillary arch continued. Further rotation of the braincase, about its three axes, completed disengagement of the ipsilateral jaw elements and progressed them along the prey. The rotations of the braincase thus produced a screw-like movement such that greater advance of the jaws over the prey was achieved than by simple jaw protraction alone. The protraction of the palatamaxillary arch, relative to the braincase, became pronounced. Rotating about its articulation with the ectopterygoid, the pterygoid swung downward. Consequently, the angle between the articulated palatine and pterygoid became more acute.

By the end of advance, the quadrato-supratemporal joint had moved to a more dorsal and medial position than at the beginning of advance. The ectopterygoid was pushed forward by the protracting pterygoid bone and in turn pushed the ectopterygoid-maxillary joint forward relatively to the braincase. Consequently, the maxilla only slightly erected during advance, but in turn it pushed the prefronto-maxillary joint into a slightly more dorsal position by the end of advance. During advance in swallowing the fang was either not or only partially erected. Full erection was avoided mechanically due to an enlargement of the projected angle in the pterygoid, which was achieved by an outward rotation of the pterygoid around a vertical axis through its anterior part (Dullemeijer & Povel, 1972). The direct contact with the quadrate was lost. The quadrate swung forward and translated somewhat dorso-medially.

Close

The cranial elements that have just cleared and advanced along the prey now closed. In the lower jaw, the anterior end of the mandible was first adducted then retracted. Its posterior end swung posterolaterally. In the upper jaw, the palatamaxillary arch was also retracted. Thus, the maxilla folded back into a retracted position and the palatopterygoid joint moved backward straightening the angle between both articulated bones. The pterygoid retracted slightly, but not in a simple fashion. In addition to retraction, the pterygoid, turning about its articulation with the ectopterygoid, rotated in a horizontal plane. Its anterior end swung medially and its posterior end laterally. The quadrato-supratemporal joint moved ventro-laterally.

3.2.2.2 *Fixing phase (Fig. 5B)*

As opening, advance, and close occurred on the opposite side, the braincase similarly rotated about three axes: horizontal, vertical, transverse. But, motions were, of course, the mirror images of the actions during ipsilateral displacement. The result, for the contralateral elements, was to press the jaws into the prey. The palato-maxillary arch and quadrato-mandibular joint were retracted and moved laterally. The quadrato-supratemporal joint was also depressed during advance of the ipsilateral side and moved upward during closing.

3.2.2.3 *Swallowing Cycle Overall*

Variation in the swallowing cycle did occur, although much of this variation arose from the lengthening, shortening, or overlap of various stages of the cycle. For instance, advance often began with the onset of opening. The calculated muscle forces are taken from such a cycle.

Each swallowing cycle was usually separated by a rest interval. If there were any swallowing motions between cycles, it was evident in the neck, where slow lateral body curves swept posteriorly toward the stomach. Within each cycle there was a short period of relaxation between both phases. Occasionally no break between the two phases could be identified in bone motion or muscle activity.

The cervical region played a critical part in swallowing (Dullemeijer, 1959; Kardong, 1977). As the jaws progressively advanced over the prey, the neck became more involved in swallowing both by formation of more pronounced lateral undulations that act on the bolus, and by straightening of the cervical region to push the head beyond the prey. As during each swallowing cycle the jaw lifted and moved forward, straightening of curves in the cervical region pushed the cerebral skull slightly forward.

3.3 *Muscle Activity*

3.3.1 *Strike (Fig. 6)*

During the strike all muscles, adductors and abductors, reached their peak output. They contracted and relaxed in less than one second; their activity seemed to be nearly simultaneous, however, there was a specific contraction pattern. On the basis of this pattern, the strike can be divided into two phases, first jaw opening, second jaw closing (with envenomation). Many muscles were active during both phases, although muscle activity was considerably less during the opening than during the closing phase.

During the opening phase, activity appeared first in the depressor muscles. At about the same time, low activity was registered in the levator pterygoidei, the adductor superficialis, and the adductor pterygoideus. These activities were followed by low activities of the compressor glandulae and the protractor pterygoidei.

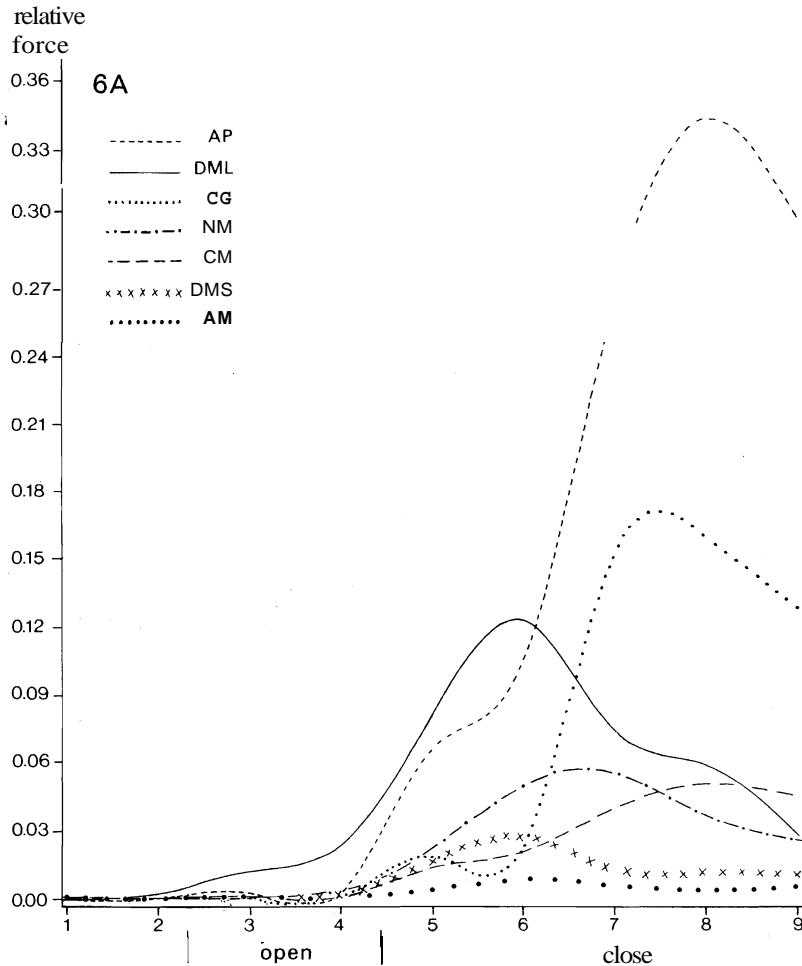
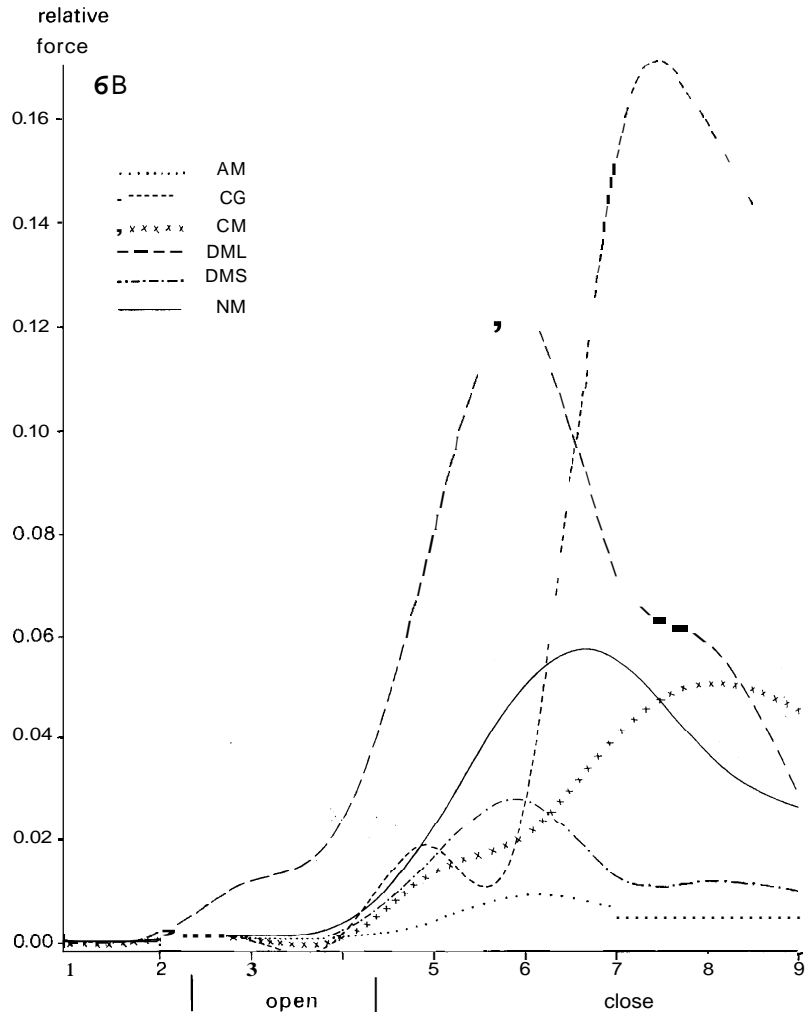

Fig. 6. Strike. Relative muscle forces during the strike. Two separate strikes are shown (A/B and C/D). Electrodes were on the right side in A and B, and on the left side in C and D. The forces plotted are relative forces. The relative forces are in kg/cm^2 (see text). Each time unit is equal to 0.09 sec. The lower relative forces of six muscles in A are shown on an expanded scale in B. Similarly, the lower relative forces of six muscles in C are shown expanded in D. For abbreviations of names of muscles see Fig. 3.

During the closing phase, groups of muscles act in sequence. First to peak were the levator pterygoidei, adductor superficialis, and adductor medialis; second, followed the neuromandibularis, protractor pterygoidei, adductor pterygoideus (pars glandulae), and compressor glandulae; the third group included the cervico-mandibularis, retractor pterygoidei, adductor profundus, and adductor pterygoideus. Of all of the jaw muscles the adductor profundus and adductor pterygoideus produced the greatest tensions.



3.3.2 Swallowing (Fig. 7 & 8)

3.3.2.1 Jaw Moving Phase

Muscle activity varied in relation to swallowing progress. Early in swallowing, muscle activity was low and many muscles were almost silent. When the swallowing had progressed to about halfway along the prey, several muscles reached higher peak activity levels.

The protractor pterygoideus was the first muscle to show activity that progressively increased to eventually peak near the end of open/advance. The depressor mandibulae also showed early activity noticeable as jaw opening began although peak force was

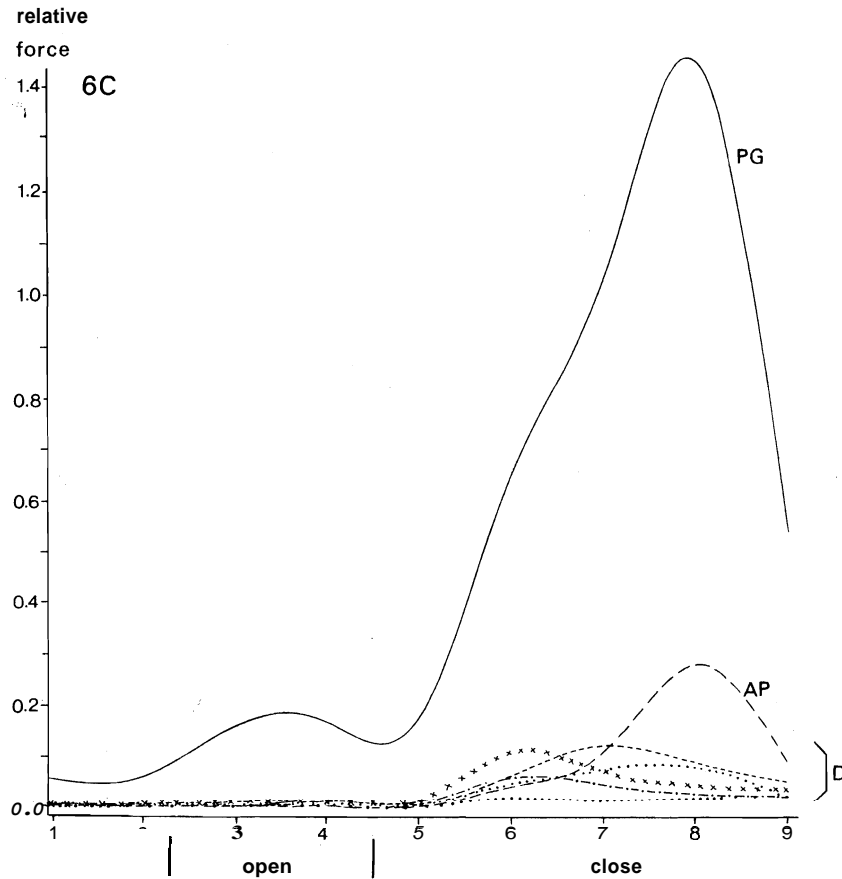

reached in the depressor mandibulae cranialis later than in the depressor mandibulae lateralis. The lateralis was the larger muscle of the two and generated the greatest force. The depressor muscles remained active during open/advance and closing.

In open/advance some other muscles showed first signs of activity: the adductor pterygoideus including the pars glandulae, the compressor glandulae, the adductor medialis, and the retractor quadrati. Only the depressor mandibulae, the protractor pterygoidei and the retractor quadrati attained their peak tensions during open/advance.

Tension in most muscles peaked at the beginning of or during closing: the neuro-mandibularis, the adductor superficialis, the compressor glandulae, the adductor medialis and profundus, and the adductor pterygoideus complex. During closing, the protractor pterygoidei and the retractor pterygoidei were silent, and the retractor quadrati and the cervicomandibularis showed low activity. There was, however, varia-

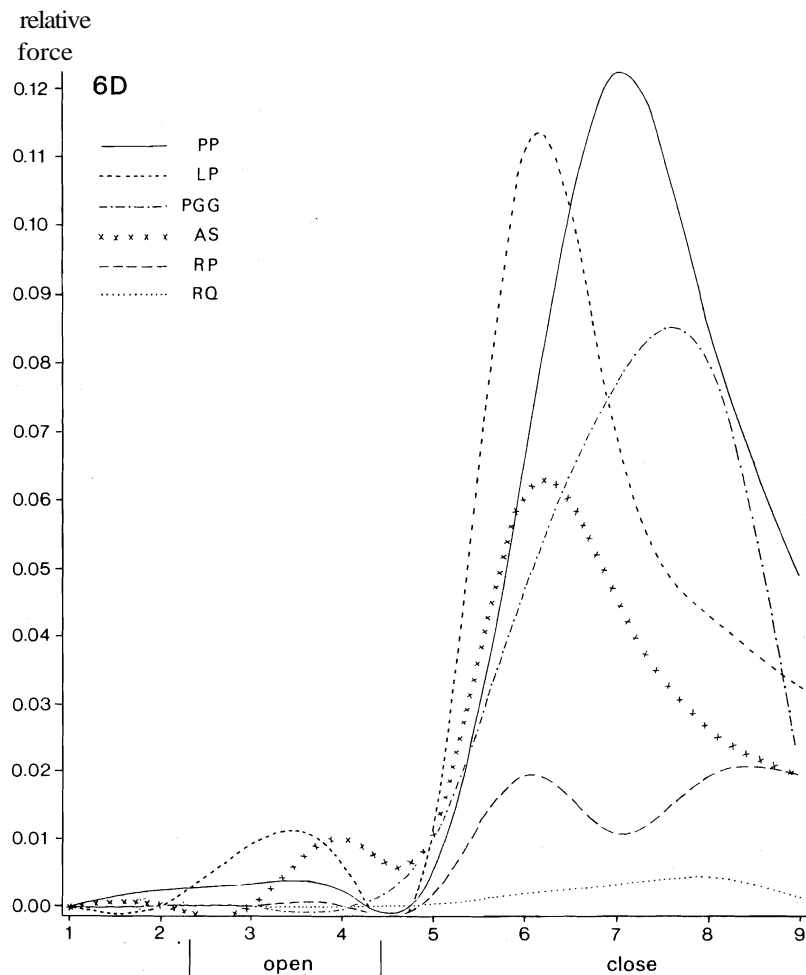

tion in peak tension achieved by each muscle that depended upon the point reached in the swallowing process and upon obstacles (limbs, prey body shape) the snake encountered.

3.3.2.2 *Jaw Fixing Phase*

During the fixing phase, all lateral jaw muscles generated at least low levels of force except the adductor superficialis which was silent. Three muscles, the cervicomandibularis, the neuromandibularis, and the adductor medialis, reached nearly equal forces during both moving and fixing phases. Maximum force was reached during the fixing phase only in the levator pterygoideus and the retractor pterygoideus. All other muscles reached their greatest swallowing force during the moving phase.

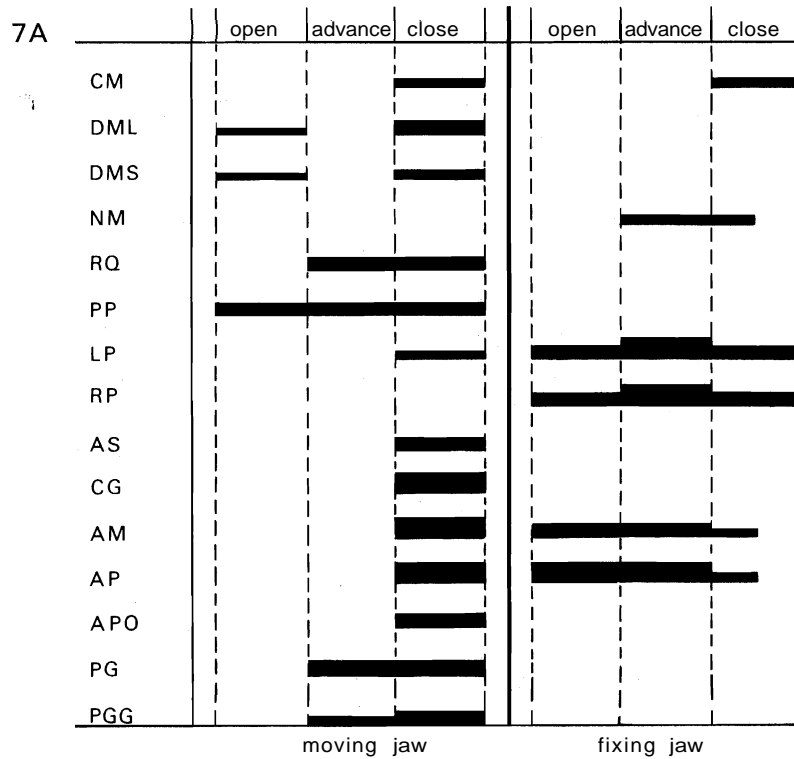

Fig. 7. Diagrammatic myograms during swallowing. As explained in the text, the maximum myogram reached during either phase, ipsilateral or contralateral, was taken as the standard, divided into three levels (maximum, intermediate, baseline), and then the remainder of that same muscle's spike train was best fitted visually to one of these three categories. These block diagrams are thus proportional in height to muscle activity. Open and advance parts of each phase tended to overlap in those sequences used to compile this summary. A, early in swallowing. B, mid-swallowing. For abbreviations of names of muscles, see Fig. 3.

4. Forces

4.1 Strike (Fig. 9)

Using the yawn as a model for the strike, the positions of the movable elements during the initial strike were determined. From dissection work, the lines of action of the muscles were established. From measurement of muscle cross-sectional area and electromyography during the strike, relative forces could be determined. The vectors are shown in figure 9.

4.1.1 Muscle Actions

The depressor mandibulae contributes during the strike to the opening of the mandible. This is suggested by the lines of action of both parts and by the attainment of peak

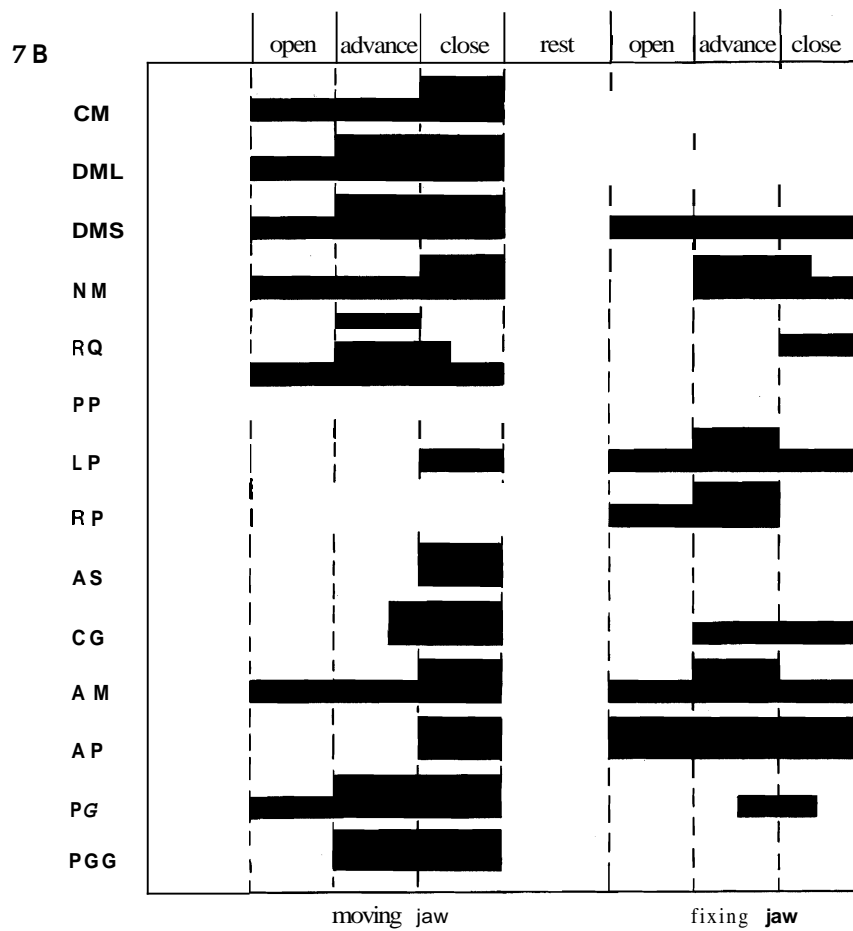

activities early in the strike just as the lower jaw begins depression. Similarly, lines of action of the levator pterygoidei and the protractor pterygoidei together with their elevated activity as the palatamaxillary arch begins protraction suggest that they contribute to the forward transport of the arch and hence erection of the fang.

The time of peak activity in the compressor glandulae and adductor profundus together with their lines of action clearly implicate them in jaw closure as the snake bites into the prey. Further, the attachment of the compressor glandulae to the venom gland implicates this muscle in venom ejection at this same moment.

However, determining the action of other jaw muscles is less straight forward. For instance, the adductor superficialis and medialis, both presumably best suited to jaw closure judging by their lines of action, reach peak activity when the jaws are opening. Similarly the retractor pterygoideus, which lies along a line of action favorable to

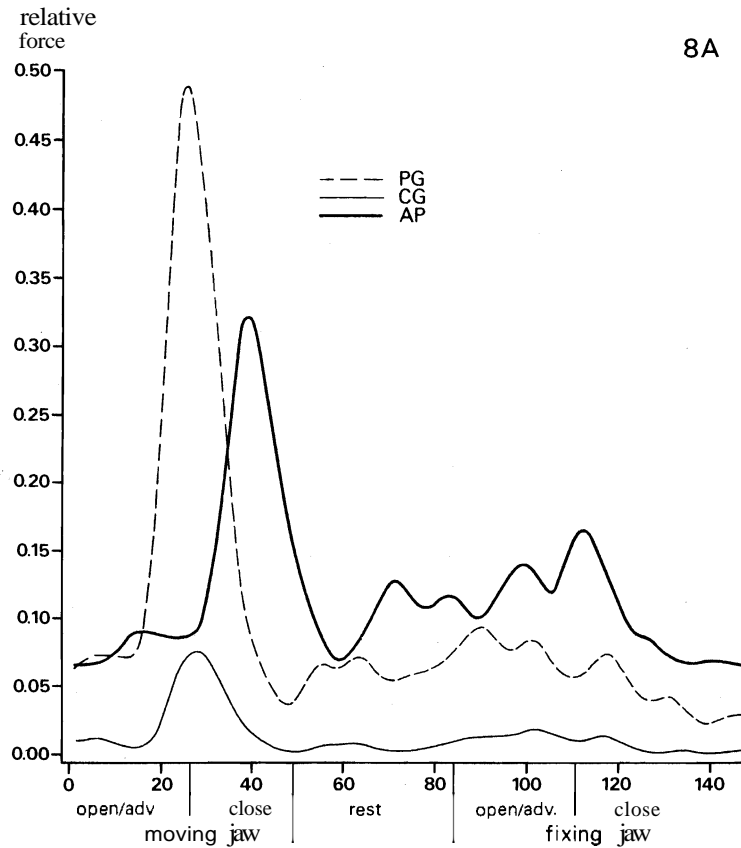
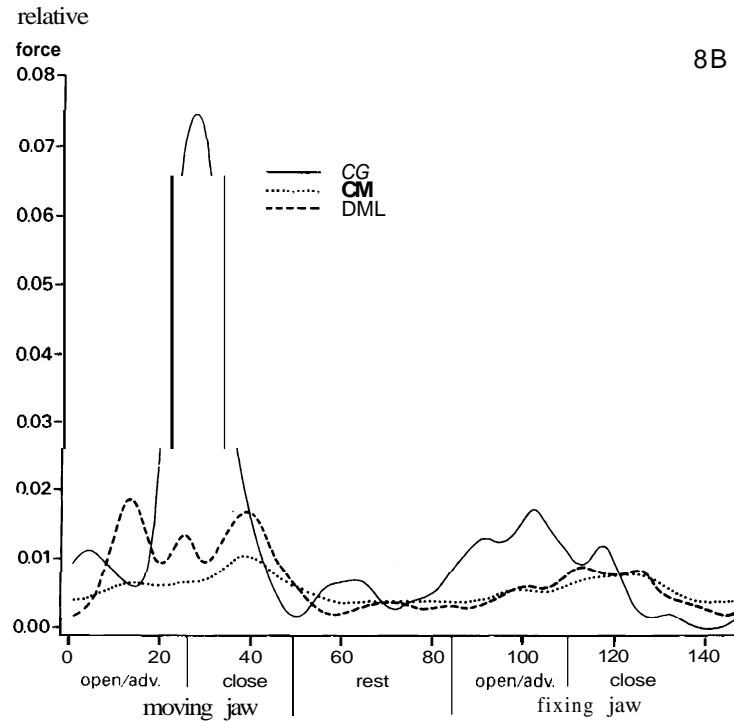

Fig. 8. Swallowing. Relative muscle forces during swallowing. Two separate swallowing sequences are shown (A/B/C and D/E/F). Electrodes were on the right side in A/B/C and on the left side in D/E/F. As explained in the text, relative muscle forces are expressed as a proportion of the maximum myogram experienced during the strike preceding swallowing. The scale expands from A to C and from D to F to better reveal the lower force levels of some muscles. For abbreviations see Fig. 3.

palato-maxillary arch retraction, is active as this arch is actually protracting. This places the retractor pterygoidei in antagonistic opposition to the arch protractors (levator pterygoideus and protractor pterygoideus). However, since the total force of these arch protractors easily exceeds the force produced by the retractor pterygoidei, arch protraction and hence fang erection proceeds. Perhaps, activity of the retractor pterygoidei early in the strike betrays its involvement in elevation or control of the anterior part of the palatomaxillary arch. Whatever its function during the strike, the retractor pterygoidei seems to contribute more than just to retraction of the arch and folding back of the fang at the end of the strike.

In the strikes monitored by electromyography, the activity of the adductor superficialis and medialis similarly pose a problem of interpretation, because they reach



peak force when the jaws are opening not during jaw closure as their lines of action might imply. Perhaps they too serve to stabilize or guide the lower jaw during opening.

The adductor pterygoideus is at peak activity late in the strike. At this time, the jaws of the snake are closing or closed on the prey with fangs embedded. The adductor pterygoideus thus seems foremost to function as a powerful jaw adductor during the strike. But, this muscle may do more. It runs between the retroarticular process (next to the mandibular joint) and the ectopterygoid. It thus links the mandibular arch with the palatoquadrate arch (sensu Kardong, 1974). So strung between these arches, it could, upon contraction, act as a stiffening mechanism during penetration of the fang.

The lines of action of the depressor mandibulae imply a role in jaw opening. However, during jaw closure the mandibular depressors remain somewhat active as does the neuromandibularis. There seems to be no alternative than to suggest that their antagonistic activities at this point in the strike serve to regulate or stabilize jaw movement.

4.2 *Swallowing* (Fig. 10)

Bone positions, determined from X-ray analysis, are shown for two parts in the swallowing cycle: moving phase—advancelopen and close, and fixing phase—

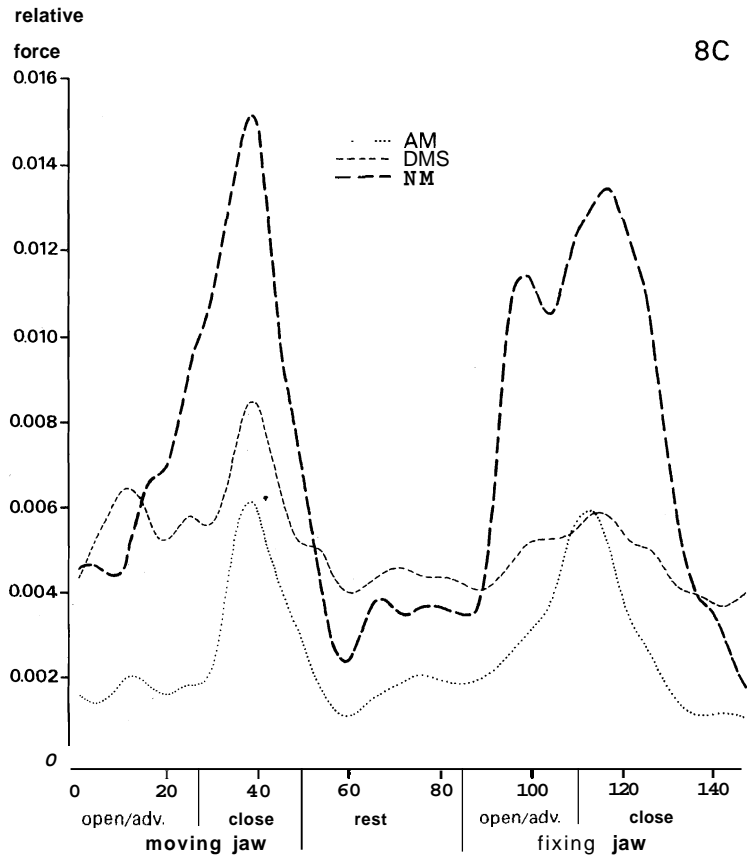

advance/open and close. Dissection established lines of muscle action. Electromyography gave peak activity times for muscles. Relative forces were calculated (see Materials and Methods) at each respective point in the swallowing cycle. The resulting relative force vectors during the moving phase are shown in figure 10.

4.2.1 Muscle activities

The muscle forces during swallowing are a small fraction, about a tenth, of the forces for the same muscles during the strike. Several muscles seem to be especially critical for jaw opening and palatomaxillary arch protrusions, namely the depressor mandibulae, the adductor pterygoideus, the protractor pterygoideus, and the compressor glandulae.

Because of its greater cross sectional area, the lateral head of the depressor mandibulae exerts a slightly larger force than does the smaller cranial head. Other than this, both heads of the depressor mandibulae are active almost simultaneously during swallowing (and during the strike). Further, both parts insert on the retroarticular pro-

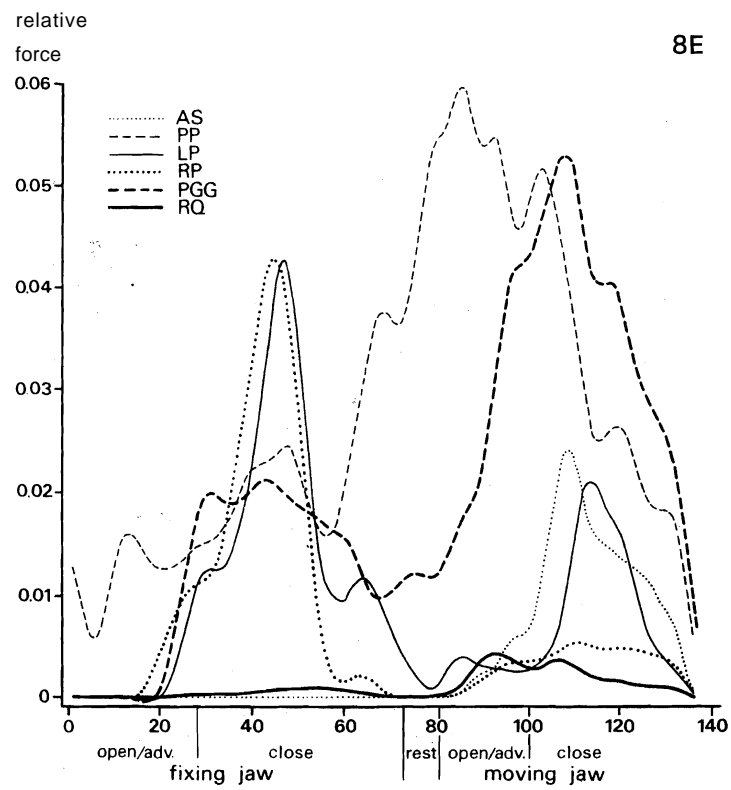
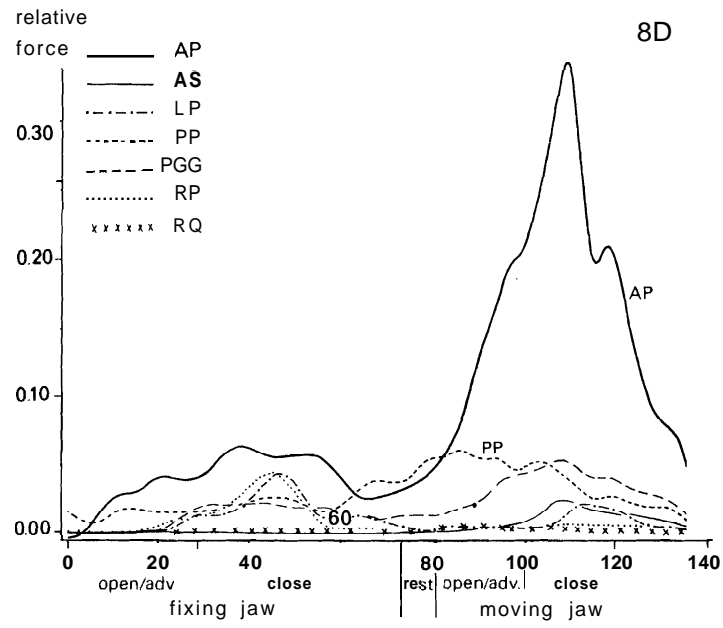

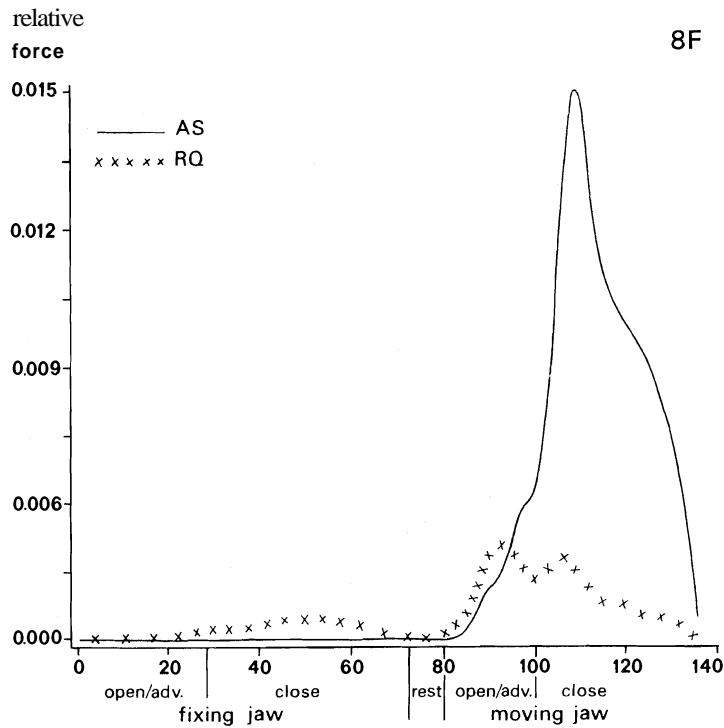

cess. Thus, if there is any separation of functional roles between these two heads, it must be fairly subtle.

The adductor pterygoideus reaches a large force late in advance and on into early closing. Such an activity pattern implicates the muscle in mandibular protraction during late advance and in retraction of the maxilla and the fang during early closure.

The force generated by most muscles quickly builds, peaks, then precipitously falls. The depressor mandibulae is one exception to this general pattern. Both its cranial and lateral heads reach an oscillating level and remain there during ipsilateral opening, advance, and closing. The protractor pterygoideus is the other exception. Its force gradually builds, then drops at the end of ipsilateral advance. Such a pattern of force output argues that the protractor pterygoideus functions to transport the palatomaxillary forward at least until the jaws begin to close.

Most muscles have a distinctive high force generation during the moving phase and reach a much lower force during the fixing phase. (The cervicomandubularis, the neuromandibularis, and the adductor medialis are exceptions to this in that they reach nearly equal, but low, force peaks during both moving and fixing phases). Hence, each muscle shows at least some activity during some part of both phases. Thus, a muscle serves different functions in each phase or if serving the same function it contributes to an unequal degree in both phases.

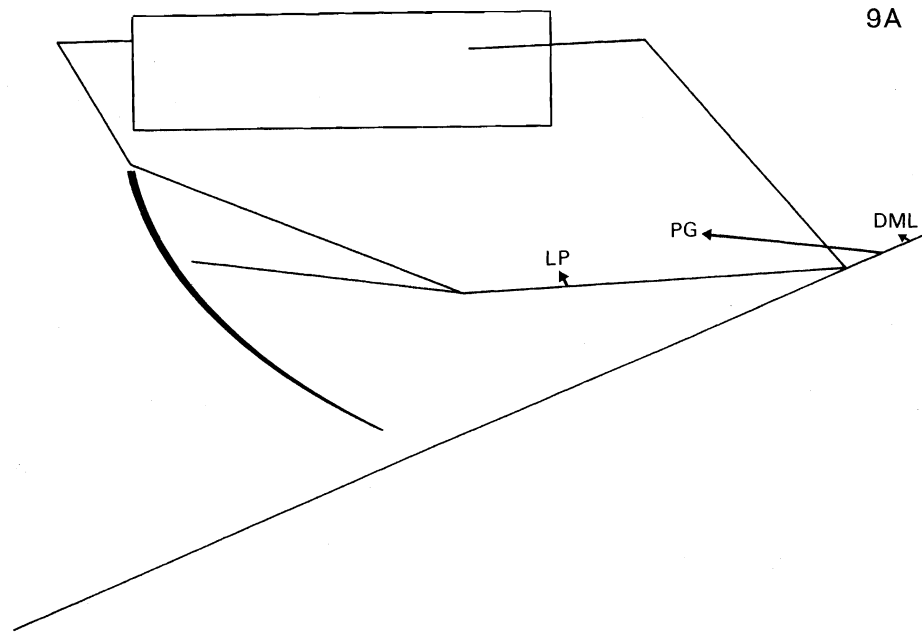

Fig. 9. Relative force vectors during the strike. A and B, at time points 3 and 7. The time points are 0.092 seconds apart. In B, PG vector is the sum of the two parallel vectors (for convenience of presentation). For abbreviations see Fig. 3.

The depressor mandibulae is not the first muscle to show activity, but it is one of the earliest to begin contraction. In *Nerodia*, this abduction of the lower jaw likely counteracts the activity of the mandibular adductors (or vice versa), thus the depressor serves to depress the mandible only enough to keep the dentary tooth row free of the surface of the prey (Cundall & Gans, 1979). The same function seems to hold here for this muscle in *Crotalus durissus*.

The neuromandibularis is almost equally active during jaw opening and closing, so it may aid in mandibular depression at one phase in swallowing cycle and then almost equally serve during jaw closure in the second phase. However, its activity during closure may not be so much abduction of the mandible, but retraction bringing the shaft of the mandible back into contact with the prey.

5. Discussion

5.1 General

The interpretation of the preceding experiments and observations depend on the accuracy and amount of data collected. Two factors are of major importance: the adequacy of the used techniques and the number of observed animals.

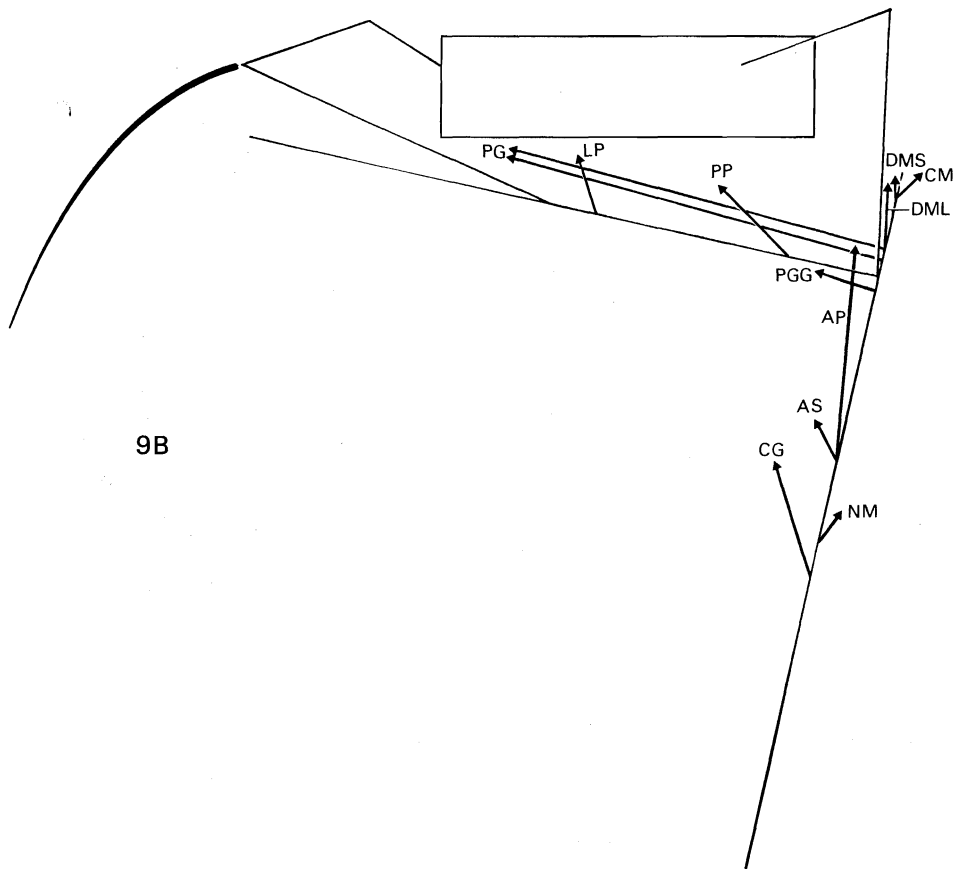

The cinefluorography provided the highest resolution for tracings which is possible nowadays and allowed the description of movements required for this study. Many observations of the feeding behaviour, not particularly mentioned, gave us confidence that the animals in the experimental situation were acting normally and that there was no reason to believe that the movements observed in the cinefilms and the registered activity of the muscles during myography were special cases or abnormal features. Variability of the feeding patterns in individuals due to differences in food and feeding phases were observed. However, we refrained from discussing this variability in this paper, because for well-founded conclusions more sophisticated techniques should be applied.

In the chapter on techniques we have already explained why we feel it to be warranted to use unipolar silver electrodes. Aspects of "view" of the electrodes, volume conduction and antenna effects could be recognized and if occurring we refrained from drawing conclusions from these outputs. The resolution in the description of the

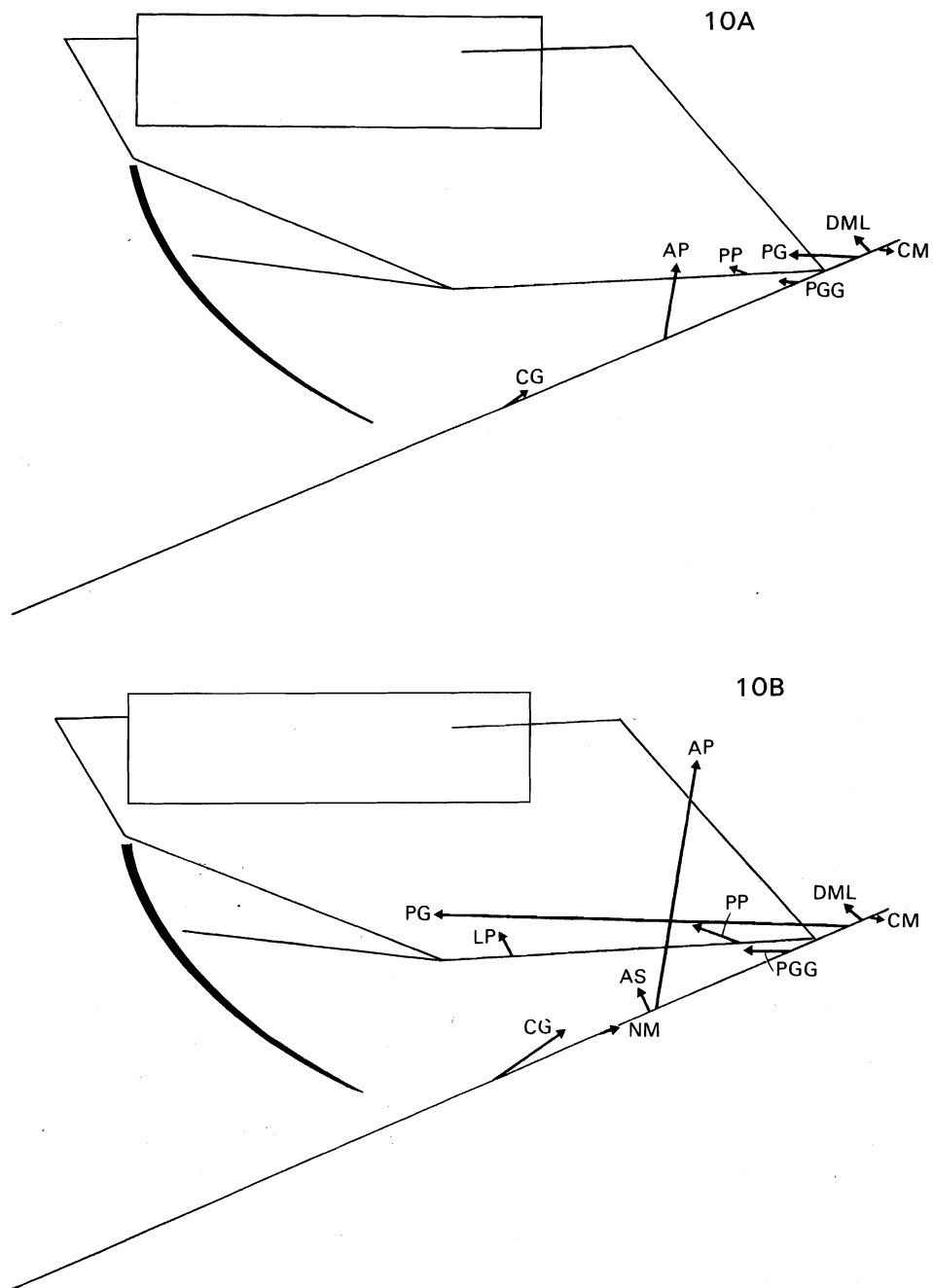

Fig. 10. Relative force vectors during the moving phase of swallowing. A, open/advance. B, closing. Many other muscles were active but their vectors were too small to indicate in the figure (see Fig. 8). For abbreviations see Fig. 3.

myographic output meets the demands of answering our question i.e. which is the order and relative magnitude of muscular activity.

Notwithstanding that only two animals were experimented on we have the opinion that from these cases some general conclusions can be drawn.

5.2 Functional significance of some structures

During jaw advance in *C. durissus*, the upper jaw "jackknives" downward at the palatopterygoid joint. In contrast, this joint swings laterally in *Agkistrodon piscivorus* (Kardong, 1977), and is slightly elevated in *Nerodia* (Cundall & Gans, 1979). The comparative structural or functional significance of these differences in the several species is not clear.

The ectopterygoid-ptyergoid joint permits the articulated ectopterygoid bone to rotate in a vertical plane describing an angle between ectopterygoid and pterygoid of up to about 25°. However, firm ligaments and interlocking processes at this joint prevent twisting of the ectopterygoid about its long axis or significant sliding of the ectopterygoid on the pterygoid. Thus, in *Crotalus durissus* this joint is restrictive similar to that reported in other snakes (Kathariner, 1900; Haas, 1931; Klauber, 1939, 1956; Dullemeijer & Povel, 1972; Kardong, 1974).

Liberation of the tips of the mandibles in *C. durissus* as in other snakes, seems to be a contributor to increased gape (Gans, 1952, 1961). However, as reported in the viperid *Agkistrodon piscivorus* (Kardong, 1977), at least an equal contributor to expansive gape is the outward swing or flaring of the quadrato-mandibular joints. This lateral joint displacement during swallowing carries articulated bones outward and away from the prey. But, advance of the jaws along the prey is not due solely to jaw protraction/retraction motions. Rotation of the entire braincase, especially in a horizontal plane, is a major factor in swinging coupled elements around and along the prey.

Further, some previous models of snake jaw kinesis have underestimated the role of the elements on the fixing side in accomplishing swallowing. In *Crotalus durissus*, as in *Agkistrodon* (Kardong, 1977) and *Nerodia* (Cundall & Gans, 1979), as their opposite partners take their turn to open and advance along the prey, contralateral elements experience strong retraction by retractor muscles. Thus, as opposite partners are "reaching around and forward", the contralateral elements are "pulling" the prey farther backward.

The complex displacement of movable cranial elements together with documentation of retraction forces via electromyography tends to make it appear as though swallowing motions draw the prey into the esophagus (Boltt & Ewer, 1964). However, quite the reverse occurs (Kardong, 1977; Cundall, 1983). The mechanical strategy of swallowing involves the advance of the relatively light jaw elements over the relatively heavy prey rather than the actual pulling of the prey into the mouth. This is a strategy employed throughout swallowing, but is emphasized even more as swallowing progresses. Late in swallowing, the walls of the esophagus compress and hold the bolus

while straightening of vertebral curves in the cervical region push the cranium forward and thus advance it along the prey. The distensibility of soft tissues in the throat and neck permits expansion of the alimentary canal to accommodate large prey. But further, this flexibility of soft tissues allows greater freedom of movement of the bony cranium and advance of jaws over the prey.

The focus of this study was upon feeding stages in which the angle of the jaws passed over the middle part of a large, adult mouse swallowed head first. However, observation of other stages of the feeding cycle indicate that EMG patterns, force generation, and kinesis are variable. For instance, jaw kinesis was more pronounced when the snake first began to swallow the prey; when the prey got into the back of the mouth and continued into the esophagus, the neck musculature became more and more prominent in contributing to passage of the prey; a small prey, a prey swallowed posterior end first, or a protruding prey appendage that causes some difficulty for the snake all resulted in changes in muscle activity both in the form of a slight alteration in sequence of activity and in peak forces achieved.

5.3 *Structural consideration*

5.3.1 *Bones*

The force vectors determined in this study were used to interpret the shape of structural elements that withstand and transmit forces within the jaw system.

One distinctive feature in the jaw apparatus of these snakes is the high degree of kinematic freedom enjoyed by the bony linkages. A second noteworthy feature is the observed involvement of the majority of muscles in almost all phases of the strike and swallowing. Certainly, the degree of activity of the muscles varied, but to some extent depressors were active during adduction, adductors were active during depression, etc.

Both the prefrontal and maxilla have but one degree of freedom, although the maxilla might be moved slightly laterally when unusually large forces are applied. If such large forces occur, they only occur when the fangs are embedded in the struggling prey. In fact, the lateral give in the prefrontal-maxilla articulation may provide a margin of safety to relieve lateral stress on the joint. By contrast, the other movable bony elements of the skull enjoy many degrees of freedom. As part of a linkage chain, these bones potentially experience movements that are indeterminate. Their control and positional changes are thus largely carried out by the direct, selective action of muscles. The highly kinetic skull and accompanying complex system of muscles is an adaptive feature to swallowing large prey. The elements can be adjusted to many prey shapes. The bony jaw apparatus is a combination of two functional components: the striking component and the swallowing component. To the former belong the prefrontal, the maxilla with the poison fang, the ectopterygoid, the caudal part of the entopterygoid. These elements have an almost determinate movement pattern with only slight deviations due to some give in the connective tissue and occurring to adapt to various prey sizes and shapes. The supratemporal, the quadrate, the entopterygoid

and the palatine belong to the swallowing component. They are far less determinate due to very loose connections; their movements are mainly controlled by muscles.

The lower jaw needs special consideration. It is necessary for swallowing but its significance for striking can be questioned. A stab would be an ideal strike mechanism. We observe indeed a far downward movement of the lower jaw. However, the poisoning needs an employing of the gland with a muscle attached to the gland (Dullemeijer, 1959) and to the lower jaw. Thus the lower jaw is primarily an element for swallowing, only a small part has a function in the strike. If, however, the strike needs to be a bite to penetrate the fang (the question stab or bite has not been solved yet) then the *entire* lower jaw is to be a necessary element for the strike. Such a combination is also found in the caudal part of the pterygoid. This part serves primarily for the strike and is only of little use to swallowing. Both lower jaw and pterygoid combine these functions optimally, although the lower jaw must be turned away at the start of the strike and the pterygoid part is lifted upward as far as possible during swallowing.

5.3.2 Muscles

We can ask whether the muscles can also be divided into two groups: one for the strike and one for the swallowing. This does not seem to be so, although the force output, and particularly the relation between the forces, is different. The force output during strike is about 10 times larger than during swallowing. During the strike there is an explosive output of almost all muscles in a regular sequence within 0.1 second. Again adductors and depressors are active simultaneously or almost simultaneously, guiding the movement. The strike accounts for the presence of all the muscles and their respective positions and sizes.

We thus can conclude that the rattlesnake feeding muscles in the construction are an adaptation to the strike with poison injection and a quick release of the prey animal. The swallowing uses only a small part of the total potentiality, this in contrast to the bony elements in which we could distinguish two regions. The functional components for both activities thus can topographically be well distinguished in the bones (with some overlap in the border area) but cannot be separated in the muscle system.

6. Conclusions

6.1 Strike

6.1.1 As the lower jaws open, the independently suspended jaw elements, left and right, are simultaneously protracted during the strike, thus erecting the fangs.

6.1.2 All abductor and adductor muscles reach their maximal output during the strike.

6.1.3 Low levels of activity first appear in the depressor muscles, but they and all other abductors and adductors immediately thereafter reach peak output nearly simultaneously.

6.2 *Swallowing*

6.2.1 A single swallowing cycle was made up of two phases, moving (ipsilateral) and fixing (contralateral). In turn, each phase included opening, advance, and closing parts.

6.2.2 Complicated rotation of the braincase was especially critical for proper disengagement.

6.2.3 Although the basis patterns were similar, the vigorousness of bone displacement and intensity of muscle activity varied between early stages of swallowing (head of prey) to later stages (bulky body of prey).

6.2.4 Relative muscle forces during swallowing were about a tenth those reached during the strike.

6.2.5 All muscles showed some activity during both phases of a swallowing cycle although the timing of this peak activity varied between muscles.

6.2.6 Most muscles distinctly reached a peak output during just one of the two swallowing phases.

6.2.7 Not the only pattern, but the most common was for a muscle to quickly reach peak output, then its force would precipitously fall. Only several muscles showed a pattern of high, sustained output.

6.3 *General Muscle Function*

6.3.1 From relative muscle forces, vector models of the jaw apparatus during the strike and swallowing were proposed.

6.3.2 From vector models and overall pattern, the roles of individual muscles in the strike and swallowing were determined.

6.3.3 Although most muscles seemed primarily to play a part in moving bony elements, some muscles also served to stabilize or regulate cranial elements.

6.4 *General Observations*

6.4.1 Flaring laterally of the quadrato-mandibular joint serves to increase gape.

6.4.2 The prey is not drawn into the mouth but the jaws are rather advanced over the prey.

6.4.3 Each muscle plays a part in both the strike and swallowing. Its specific role in each behaviour is determined by its output level, relative peak performance to other muscles, and to its mechanical leverage upon the jaw apparatus.

6.5 General constructional conclusions

6.5.1 The bony apparatus can be divided into two functional components, with a part of the lower jaw and the pterygoid belonging to both.

6.5.2 The latter show integrated structures.

6.5.3 The muscles cannot be divided into two components. The muscles are adapted to strike and poisoning activity. Only a small amount of muscle output is used during swallowing.

Acknowledgements. Thanks are gratefully extended to Dr. T. de Cock Buning for technical assistance and sustained help throughout the experimental work. We appreciate the thoughtful contributions to this research by various persons, especially P. Snelderwaard, H.A.J. in den Bosch, S. Zeilstra, A. Smith, D. Wright, and D. Vest. Sincere thanks go to Drs. H. Zweers, W. Weijjs, and D. Cundall for stimulating discussions of various points raised in this study.

References

- Boltz, R.E., Ewer, R.R. (1964): The functional anatomy of the head of the puff adder, *Bitis arietans* (Merr.). *J. Morph.* 114: 83-106.
- Cundall, D. (1983): Activity of head muscles during feeding by snakes: A comparative study. *Amer. Zool.* 23: 383-396.
- Cundall, D., Gans, C. (1979): Feeding in water snakes: An electromyographic study. *J. Exp. Zool.* 209: 189-208.
- Dullemeijer, P. (1956): The functional morphology of the head of the common viper, *Vipera berus* (L.). *Arch. Neerl. Zool.* 11: 387-497.
- Dullemeijer, P. (1958): The mutual structural influence of the elements in a pattern. *Arch. Neerl. Zool.* 13: 174-188.
- Dullemeijer, P. (1959): A comparative functional-anatomical study of the heads of some Viperidae. *Morph. Jahrb.* 99: 881-985.
- Dullemeijer, P. (1961): Some remarks on the feeding behaviour of rattlesnakes. *Proc. Kon. Ned. Akad.* 64: 383-396.
- Dullemeijer, P. (1970): Evolution of patterns and patterns of evolution. *Forma et functio* 3: 223-232.
- Dullemeijer, P., Povell, G.D.E. (1972): The construction for feeding in rattlesnakes. *Zool. Med.* 47: 561-578.
- Frazzetta, T.H. (1966): Studies on the morphology and function of the skull in the Aoidae (Serpentes). Part II. Morphology and function of the jaw apparatus in *Python sebae* and *Python molurus*. *J. Morph.* 118: 217-296.
- Gans, C. (1952): The functional morphology of the egg-eating adaptations in the snake genus *Dasyplis*. *Zool. (New York)* 37: 209-244.
- Gans, C. (1961): The feeding mechanism of snakes and its possible evolution. *Amer. Zool.* 1: 217-227.
- Haas, G. (1929): Versuch einer funktionellen Analyse des Giftbisses und Schlingaktes von *Lachesis gramineus*. *Anat. Anz.* 68: 358-378.
- Haas, G. (1931): Die Kiefermuskulatur und die Schadelmechanik der Schlangen in vergleichender Darstellung. *Zool. Jb., Abt. Anat. Ontog.* 53: 127-198.
- Haas, G. (1973): Muscles of the jaws and associated structures in the Rhynchocephalia and Squamata. In: *Biology of the Reptilia* (eds. C. Gans and T.S. Parsons) 4: 285-490.

- Kardong, K.V. (1974): Kinesis of the jaw apparatus during the strike in the cottonmouth snake, *Agkistrodon piscivorus*. *Forma et functio* 7: 327-354.
- Kardong, K.V. (1977): Kinesis of the jaw apparatus during swallowing in the cottonmouth snake, *Agkistrodon piscivorus*. *Copeia* 1977: 338-348.
- Kathariner, L. (1900): Mechanik des Bisses der solenoglyphen Giftschlangen. *Biol. Ctrbl.* 20: 45-53.
- Klauber, L.M. (1939): A statistical study of rattlesnakes. VI, fangs. *Occ. Papers San Diego Soc. Nat. Hist.* 5: 1-61.
- Klauber, L.M. (1956): Rattlesnakes, their habits, life histories, and influence on mankind. Univ. Calif. Press 1: 1-708; 2: 709-1476.
- Osse, J.W.M. (1969): Functional morphology of the head of the perch (*Perca fluviatilis* L.). An electromyographic study. *Neth. J. Zool.* 19: 289-392.
- Osse, J.W.M., Oldenhove, M., van Schie, B. (1972): A new method for insertion of wire electrodes in electromyography. *Electromyography* 12: 59-62.
- Weijjs, W.A., Dantuma, R. (1975): Electromyography and mechanics of mastication of the albino rat. *J. Morph.* 146: 1-34.
- Zweers, G.A. (1974): Structure, movement and myography of the feeding apparatus of the mallard (*Anas platyrhynchos* L.). A study in functional anatomy. *Neth. J. Zool.* 24: 323-467.

Received. April 4, 1985